

# Hevostalli HT-225

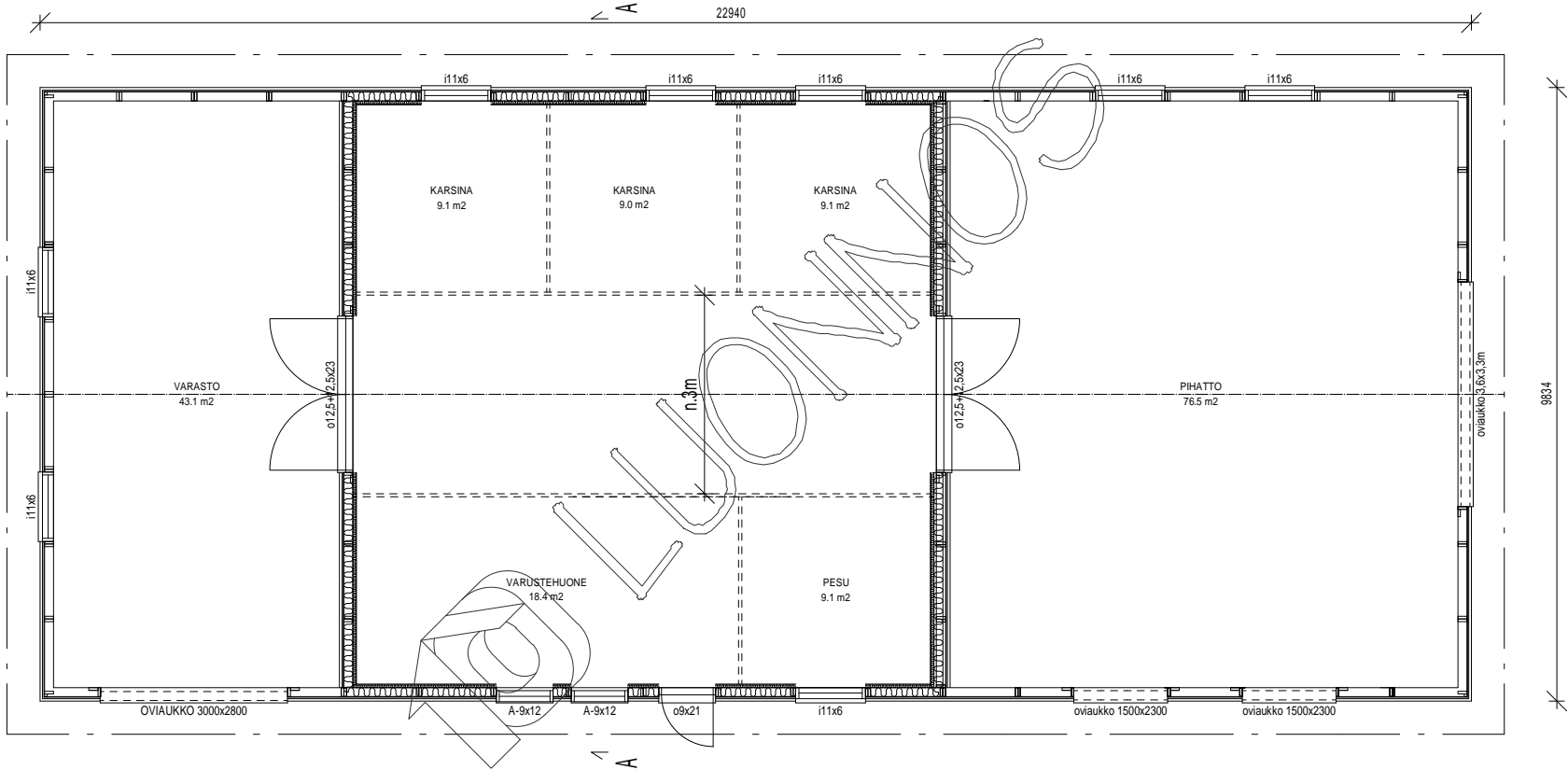

KERROSALA 225,6 m<sup>2</sup>

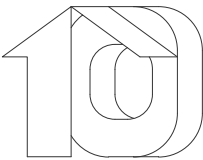

# Hevostalli HT-225

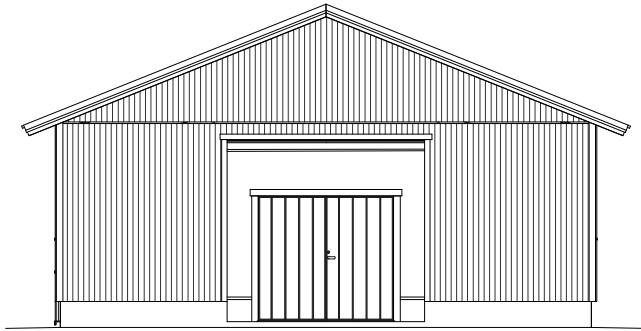

ILMANSUUNNAT ASEMAPIIRROKSEN MUKAAN

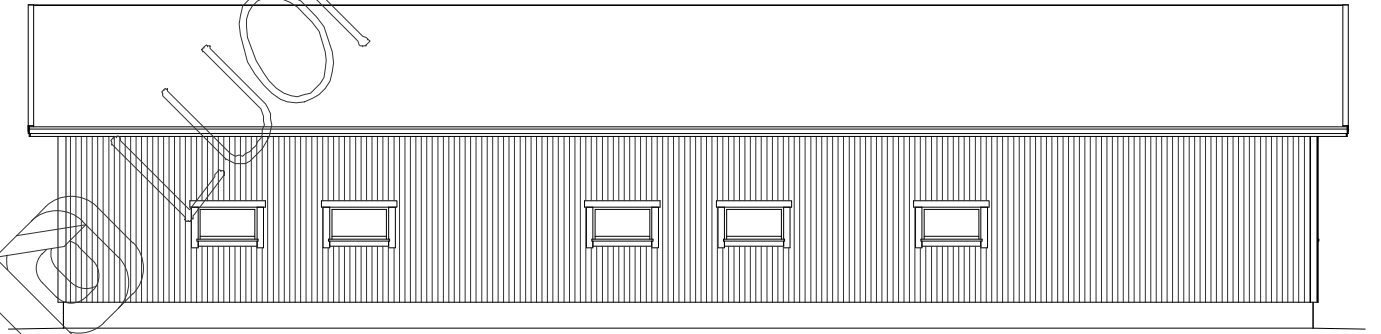
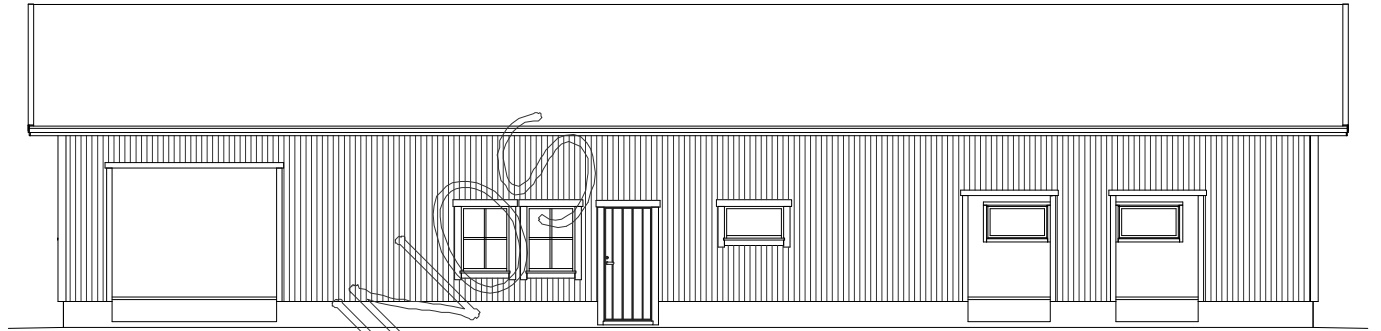
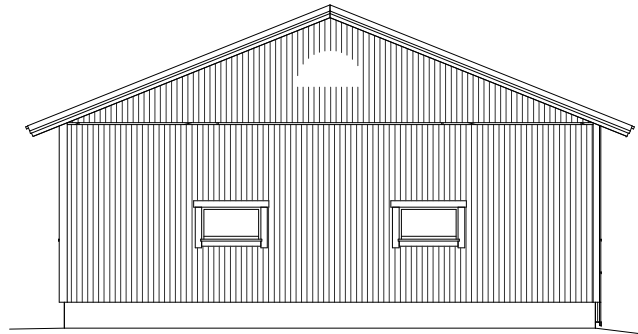

MATERIAALIT:  
PELTI-TIILI-HUOPAKATE VÄRI:  
IKKUNAT JA OVIET VÄRI:  
LOMALAUTA VÄRI:  
NURKKA- JA OTSALAUDAT VÄRI:  
SOKKELI VÄRI:



# Hevostalli HT-225

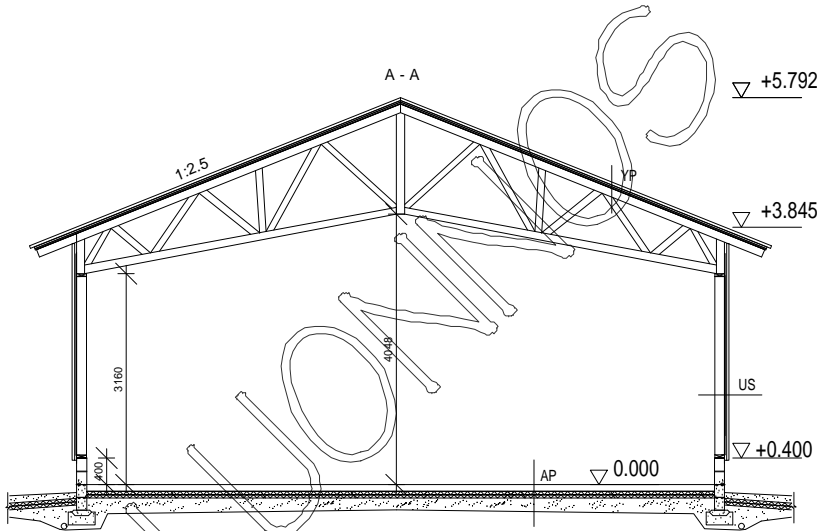

HARKKOPERUSTUS  
RAKENTEET

AP  
TERÄSBETONI 80mm + TER.  
ŠTYROX 100mm  
TIIVISTETTY KARKEA KAPILAARIN  
ESTÄVÄ SORA >200mm

US  
LOMALAUTA 20x120+20x120  
TUULETUS/NAULAUSLAUTA 22mm  
TUULENSUOJAKIPSILEVY 9mm  
RUNKO 2x4x145 k1200

YP  
PELTIKATTO  
RUOTEET 32\*100  
TUULETUSRIMA 22mm  
ALUSKATE  
KATTORISTIKKO K1200

